



## 982 3-way diverter zone ball valve

### INSTRUCTIONS

#### ACTUATOR INSTALLATION:

- 1) Line up the manoeuvre stem in the position of the servo-control manoeuvre joint.
- 2) insert the servo-control pushing it in the indicating direction.
- 3) insert the split pin in the hole.
- 4) make sure that the servo-control is correctly assembled.

The servo-control must be installed with the valves completely open.

The servo-controls are supplied in the "open" position and can be installed on all the series of ITAP zone valves.

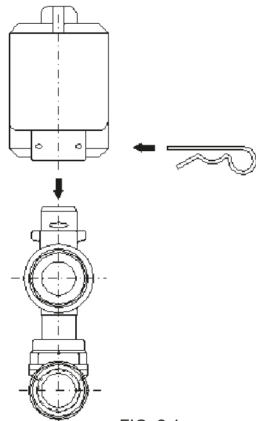

FIG. 2.1

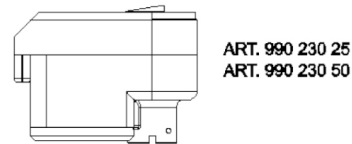

FIG. 2.2

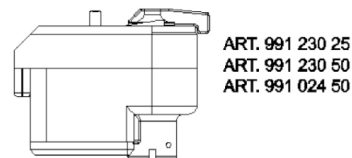

FIG. 2.3

#### 3-way Deviator Valve:

The 3-way deviator valve performs interception and deviation functions. It allows the fluid to enter from below and delivers it to the left or to the right according to the position of the servo control or vice-versa downwards from the right or the left.

Figure 4.1 shows the first case while Figure 4.2 shows the downward passage of the fluid from the right or the left. Before mounting the servo control check that the manoeuvre stem is in the correct position.

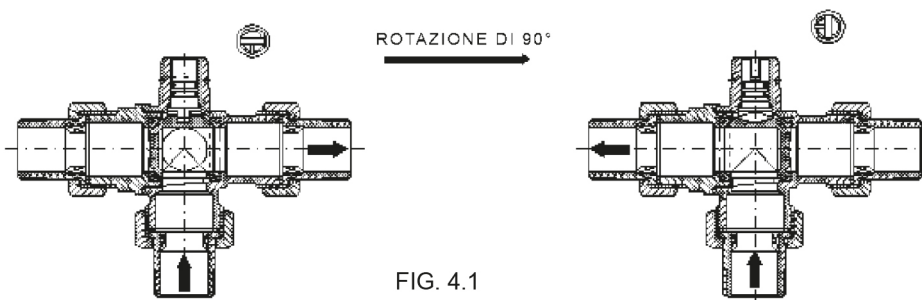

FIG. 4.1

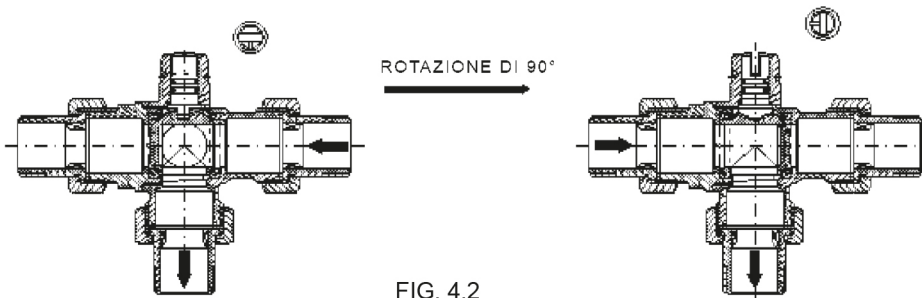
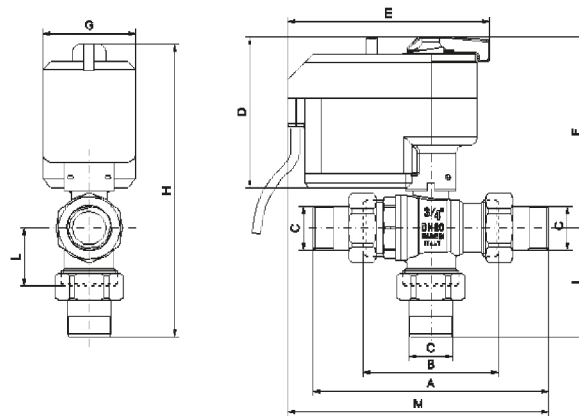

FIG. 4.2



# ACCESSORIES FOR SOLAR HEATING SYSTEMS



	A	B	C	D	E	F	G	H	I	L	M	PRESSURE kg/cm <sup>2</sup> - bar	LBS WORKING PRESSURE
3/4"	140	80	3/4"	92	120	114	55	178.5	64.5	34.5	155	16	230
1"	163	94	1"	92	120	118	55	193.5	75.5	41	166.5	16	230

## WARNING:

The servo control must never be mounted facing downwards.

When installing in metal boxes it is necessary to leave enough space above the servo control for the unblocking device manoeuvres and for eventual maintenances or replacements.

To limit the overall dimensions, position the interception valves as illustrated in fig. 7.2,7.3

To install art 986 in boxes it is necessary to correctly line up the pipes with the coplanar manifold to avoid excessive stress between the servo motor and the valve unit.

FIG. 7.1

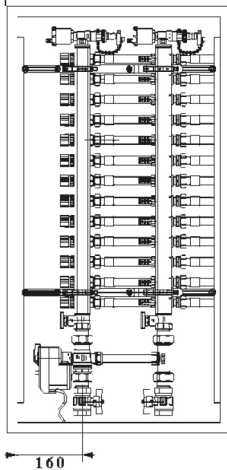

FIG. 7.2

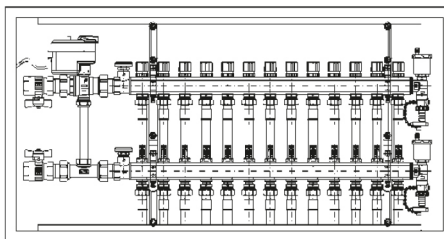

FIG. 7.3

