

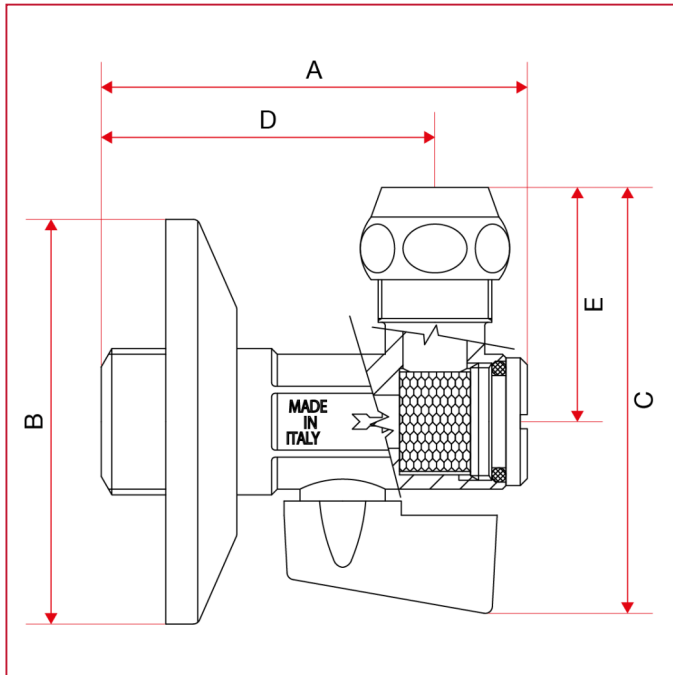

内嵌式阀门和供水阀

906 带过滤网的球型供水阀

总尺寸



	1/2"
A	60
B	55
C	60,5
D	47
E	32,8
Kg/cm ² bar	8
LBS - psi	116