

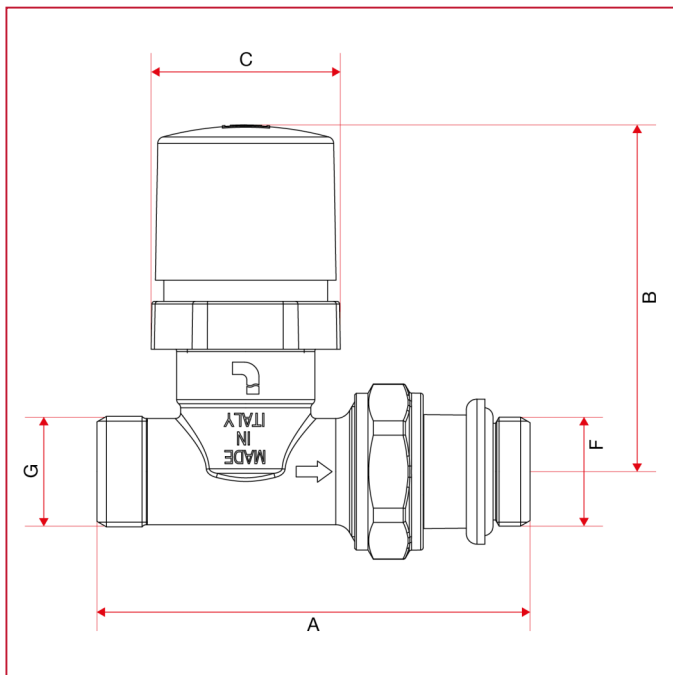

THERMOSTATVENTILE UND RÜCKLAUFVERSCHRAUBUNG

895V Gerades Thermostatventil mit Handrad, Innengewindeanschluss

GESAMTABMESSUNGEN



	3/8"	1/2"
DN	10	15
A	75,5	81,5
B	65,3	65,3
C	35,6	35,6
F	3/8"	1/2"
G	1/2"	1/2"
Kg/cm ² bar	10	10
LBS - psi	145	145