

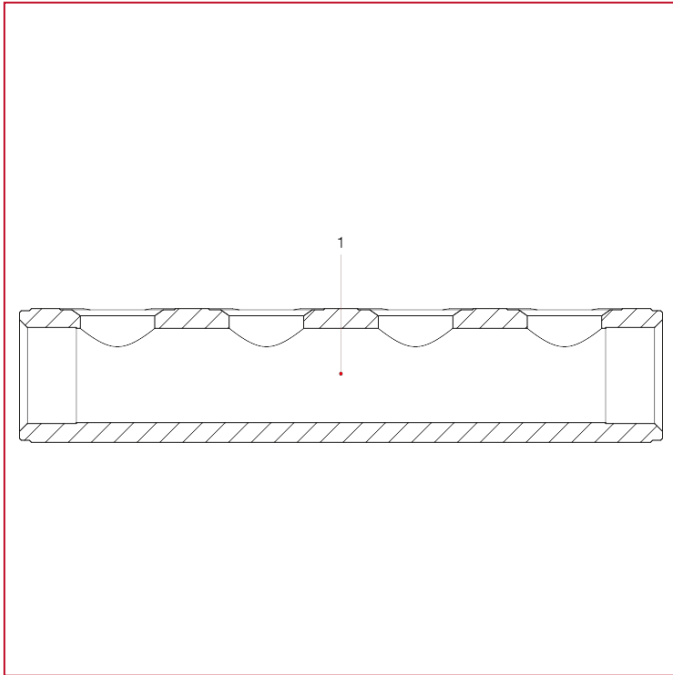

NICKEL-PLATED DISTRIBUTION MANIFOLD MADE OUT OF BRASS BAR

850/50 Nickel-plated distribution manifold made out of brass bar

MATERIALS



POS.	DESCRIPTION	N.	MATERIAL
1	Body	1	Nickel-plated brass CW603N M-S