

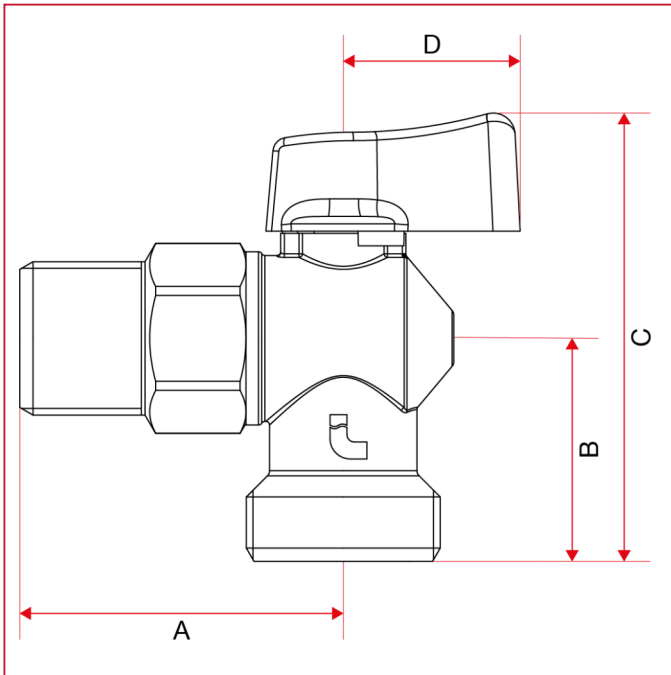

洗衣机水龙头

392 洗衣机用球阀

总尺寸



	1/2"
DN	15
A	44
B	30
C	61
D	24
Kg/cm ² bar	16
LBS - psi	232