

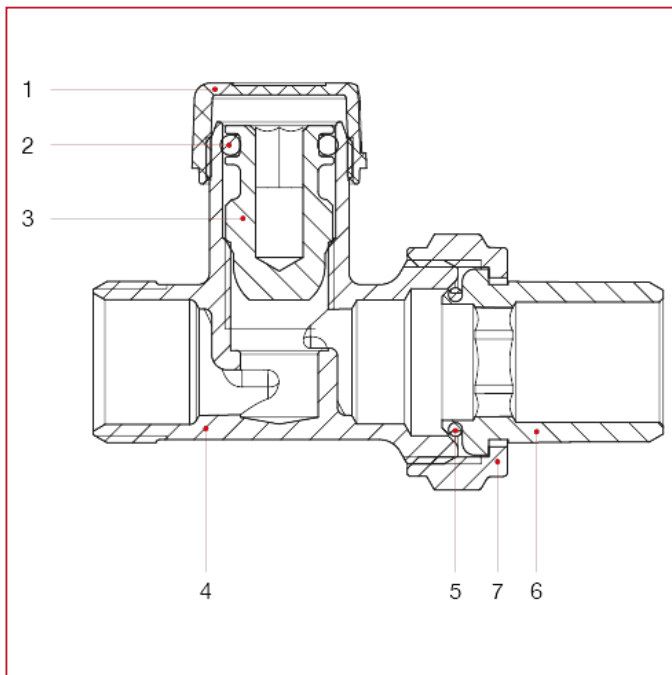

# MANUAL VALVES AND LOCKSHIELDS

## 297 Straight lockshield

### MATERIALS



POS.	DESCRIPTION	N.	MATERIAL
1	Cap	1	ABS
2	O-ring	1	EPDM
3	Bonnet	1	Brass CW614N
4	Body	1	Nickel-plated brass CW617N
5	Washer	1	NBR
6	Union	1	Nickel-plated brass CW617N
7	Nut	1	Nickel-plated brass CW617N