

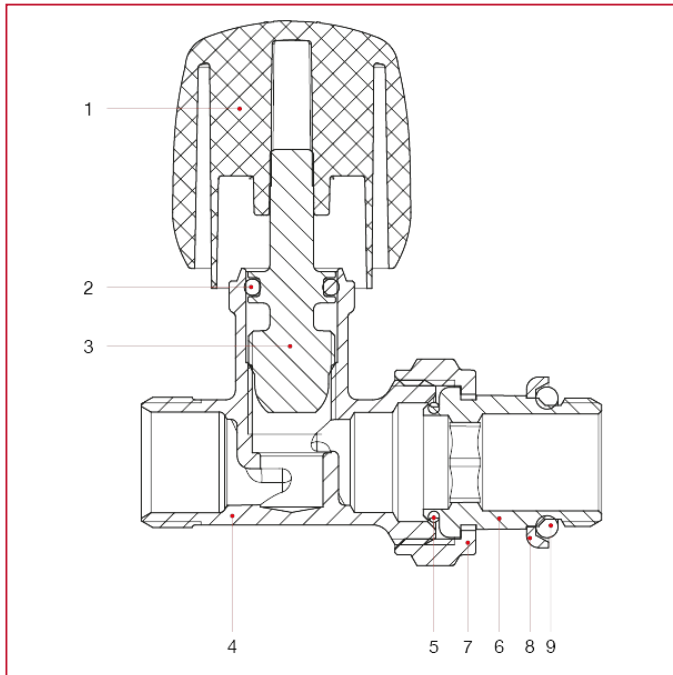

# VÁLVULAS MANUALES Y DETENTORES

## 295S Válvula recta manual

### MATERIALES



POS.	DESCRIPCIÓN	N.	MATERIAL
1	Tirador	1	ABS
2	Junta	1	EPDM
3	Tuerca	1	Latón CW614N
4	Cuerpo	1	Latón niquelado CW617N
5	Junta	1	NBR
6	Codo	1	Latón niquelado CW617N
7	Tuerca	1	Latón niquelado CW617N
8	Junta	1	Acero Fe
9	Junta	1	NBR