

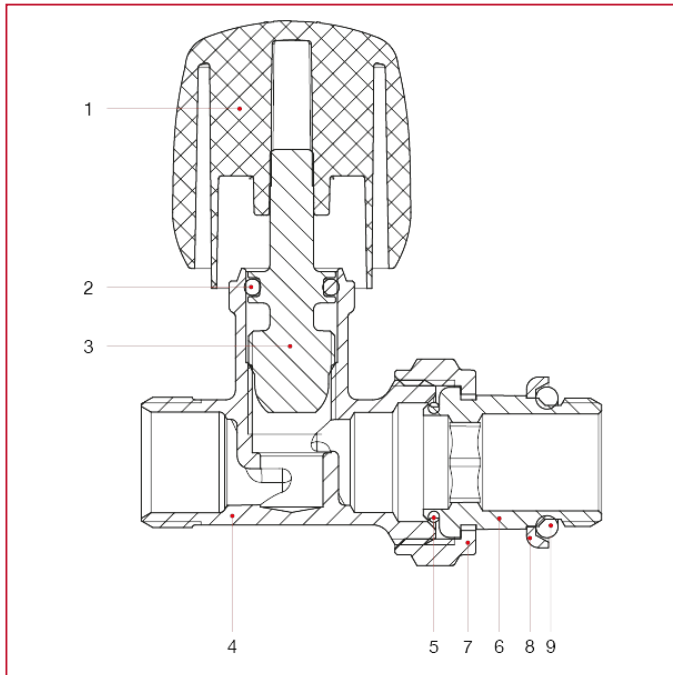

VANNES MANUELLES ET COUDES DE RÉGLAGE

295S Vanne droite manuelle

MATÉRIAUX



POS.	DESCRIPTION	Q.té	MATÉRIAU
1	Poignée	1	ABS
2	Joint	1	EPDM
3	Tête	1	Laiton CW614N
4	Corps	1	Laiton nickelé CW617N
5	Joint	1	NBR
6	Queue	1	Laiton nickelé CW617N
7	Écrou	1	Laiton nickelé CW617N
8	Bague	1	Acier Fe
9	Joint	1	NBR